

STARGATE OF ATLANTIS

# THE STARGATE OF ATLANTIS



WILLIAM HENRY

©2005 WILLIAM HENRY

### ATLANTIS

The British historian and novelist H.G.Wells put it best when he once observed, “There is magic in names and the mightiest among these words of magic is Atlantis... it is as if this vision of a lost culture touched the most hidden thought of our soul.”

Of course, by far the most illustrious of all the voices in the Atlantis choir was Plato (c. 427-347 BC) who, repeating the story of his cousin’s excursion into Egypt, reintroduced the epic story of Atlantis to the collective human imagination. He is the father of ‘Atlantology’.

According to Manly P. Hall, Plato, whose real name was Aristocles, was initiated in the mysteries in Egypt at the age of 49. His tale of Atlantis appears in *Timaeus*, in which Critias tells Socrates how, visiting the Egyptian capital Plato’s ancestor Solon (c. 640 BC) was told by a priest: “You Greeks are all children... You have no belief rooted in old tradition... And the reason is this. *There have been and will be many different calamities to destroy mankind, the greatest of them by fire and water.*”

Plato, who is considered one of the world’s greatest scholars, left little room to doubt that he subscribed wholeheartedly to the historicity of Atlantis and repeated cataclysms.

Nine thousand years before Plato’s conversation was recorded (c. 400 B.C.) a war took place between an ancient pristine Athens and Atlantis. At that time Atlantis was an island ‘larger than Libya and Asia put together’ that was overcome by earthquakes. It is the source, says Plato, of the impenetrable mud, which prevents passage beyond the Pillars of Heracles and across the Atlantic.

Plato’s description of Atlantis came shortly after the Jews were in exile in Babylon (c. 600 B.C.) and were taking history lessons from Sumerian texts that contained the missing pre-history to the Hebrew Book of Genesis. These texts speak of a massive cataclysm that destroyed an advanced race. They tell how the Sumerian gods Enki and Ninharsag intervened in the evolution of humanity and created an advanced civilization that was destroyed and how they assisted in the long march to renewing civilization. These beings were the Shining Ones of Eden and early biblical times. In Plato’s Atlantis story Enki became Poseidon, the ruler of the Atlantis.

For more than three thousand years, people have been magnetically attracted and bedazzled by Plato’s story of Enki/Poseidon’s island Empire of Atlantis and have either dismissed it as mere legend or have transformed this story into true hidden history.

Many feel that Atlantis is purely fable or a metaphor and that the ‘water’ that destroyed it is simply a symbol for a new wisdom that replaced the old.

Those who dismiss the tale of Atlantis are of Aristotle’s school. He compared his teacher’s story with that of Homer’s narrative of the wall which the Greeks were said to have constructed to protect mythical Troy, but which was destroyed by divine intervention. Aristotle’s belief was that both Homer’s tale of Troy and Plato’s Atlantis were inventions of storytellers seeking to embellish their story lines. Aristotle claimed that Plato sank the island so that it could never be found. With Homer’s *Iliad* as his guide, Heinrich Schliemann went hunting for ancient Troy in 1870. When he found it new life was breathed into the belief that Atlantis was also an actual place.

Balancing Aristotle’s view on Atlantis was Crantor (c. 300 B.C.), the first editor of Plato’s *Timaeus*. To him Plato’s story was literally and historically accurate. According to some sources, he even sent investigators to Egypt to verify the sources. Allegedly,

## STARGATE OF ATLANTIS

Egyptian priests claimed records found on still standing ‘pillars’ verified the story of Atlantis. Egypt is certainly the land of pillars. The stout columns of Karnak are unforgettable. Truly awe-inspiring are those three mysterious ancient pillars we call the pyramids of Giza, clumped together on the plateau of the gods. They represent a high science and industry capable of creating a nearly indestructible edifice. Are these the pillars of record?

Despite the fact that nearly two thousand books have been written about Atlantis in the twentieth century -- many written about the Atlantean origin of the Egyptian, Sumerian, Indo-Aryan, and native South American civilizations -- we may never be able to prove to some that Atlantis existed. Still, Atlantis reminds us of all that was once great about the human race, and can be great again. It is a state of mind, guided by the gods, glued together by far-flung ideas and a large measure of hope.

Here’s the essential story of Atlantis as told by Plato.

### PLATO’S ATLANTIS

“Once upon a time,” Plato begins in *Critias*, “the gods divided up the Earth between them.” Each took a territory and having done so populated it with humans, “their creatures and children.” The gods looked after human kind as shepherds look after their flocks, he notes, using mental telepathy to guide and persuade the mortal creatures in their care.

Poseidon’s share of the god’s earthly spoils was Atlantis and he settled the children born to him by a mortal woman in a particular district of it. At the center of the island, near the sea, on the most beautiful plain was a hill. Here there lived one of the original earth born inhabitants called Evenor, and his wife Leucippe. They had an only child, a daughter named Cleito. She was just of marriageable age when her parts died, and Poseidon was attracted by her and had intercourse with her. He fortified the hill where she was living by *enclosing it in concentric rings of sea and land, making the place inaccessible to other humans*. He equipped the central island with godlike lavishness. Poseidon begot five pairs of male twins, brought them up and divided the island of Atlantis into ten parts, which he distributed between them. His oldest son, Atlas, was given his mother’s home district. Atlantis is named for Atlas. In the center was a shrine to Poseidon and Cleito, surrounded by a golden wall through which entry was forbidden.

For many generations, Plato tells us, a ‘*divine element*’ in the nature of the hybrid children of Atlantis survived. They retained a certain greatness of mind and enjoyed a high standard of living and lives of impeccable character.

But then, the divine element in them became weakened by frequent admixture with mortal stock and their human traits became predominant. They ceased to be able to carry their prosperity with moderation, says Plato. The degenerative strain began to covet power and unbridled ambition.

The god of gods, Zeus, whose eye can see such things, became aware of the wretched state of this admirable stock. He decided to punish them and reduce them to order by discipline.

He accordingly summoned all the gods to his own most glorious abode, *which stands at the center of the universe* and looks out over the whole realm of change, and when they had assembled addressed them as follows.

## STARGATE OF ATLANTIS

Here, Plato's dialog cuts off. From this brief synopsis we have learned that the gods came to earth, mated with humans, created a new race of hybrid god-men, and built a protective enclosure for them at the center of Atlantis. After this race achieved a high degree of civilization it began to degenerate because of a dilution of 'divine essence'. Zeus, living in the center of the universe, destroys Atlantis.

I have investigated this 'divine essence' in my book *Oracle of the Illuminati*. It was also the primary subject of Gnostic text known as the *Hypostasis of the Archons* or *The Reality of the Rulers*. In short, the Gnostics believed humans possess a divine particle that is jealously coveted by a class of beings called *archons* or *rulers*. We have it. They don't. They want it.

The magical name 'Atlantis', I will contend, refers to more than just a vanished land (bridge) between Europe and America or a global kingdom that may soon arise. It is our constant craving, an irrepressible ideal; a word-symbol that conjures visions of ancient glory – a divine element -- that was lost.

Atlantis is meant to be the guiding myth of human civilization. It is the great Phoenix-bird of myths -- immolating and reconstituting over and over again. Like a psychological angel or demon relegated to the deepest recesses of the subconscious, it will rise again. The question is when.

As evidenced by their use of stellar symbolism in their religious art the initiates of ancient times knew of the precession of the equinoxes, a time-keeping system which divides a 26,000 year 'Great Year' into 12 astrological 'new ages' of approximately 2,150 years each. They predicted that humanity would make a quantum leap to a new rung of evolution's golden spiral during the Age of Pisces, which commenced during the time of Jesus and another in the second millennium AD at the beginning of the Age of Aquarius.

Time reveals everything.

### THE MEME OF ATLANTIS

Our ability to grasp the importance of the Atlantis myth to current events is matched only by our ability to absorb the astounding. Atlantis is the missing piece in the puzzle, it is the beginning and ending of all that is, the compliment to the biblical Eden and book of Revelation's New Jerusalem, the 12-gated city that will descend from the sky.

The theory of Atlantis has traditionally been studied almost entirely as a topic of archaeology, geology and history. This, however, is not the whole story. Atlantis is a creation myth ala the Old Testament book of Genesis. This means it is susceptible to many levels of interpretation, including the historical, but also the metaphorical and allegorical.

To use a modern word, Atlantis is a *meme*, a "catch all" phrase or code-symbol. Like 'America' it is a place name, but also a mental program, a matrix or realm of possibility. It is a spiritual goal.

Intriguingly, the word meme is composed of ME (pronounced 'may'), the name of the lost tablets of creation of Sumerian myth. The Anunnaki lord Enki (Poseidon in Atlantis) guarded these tablets at this temple at Eridu.

When Plato repeated this story he unleashed a mind-altering idea. Passing through the millennia and winding down road after road, through culture after culture like a river, this

## STARGATE OF ATLANTIS

tune has gained resonance. As a river seeks to find the ocean, I believe the Atlantis story is itself a stargate leading us to the cosmic ocean.

If Atlantis only exists as a brain pattern or frequency nabbed out thin air by billions of antennas embedded in central nervous systems and replicated billions of times throughout history so be it. Some claim 'Jesus Christ' is also a meme. Look at the impact such 'vibes' have on humanity. Curiously, both Jesus and Atlantis are symbolized by a cross.

As is true of the meme of the Cross the symbolic representation of and substitute for Jesus, the story of Atlantis has been passed along vertically throughout generations and horizontally among groups of like-minded individuals, the great initiates. Both stories symbolize the triumph of enlightenment over ignorance. Both teachings have been in a continuous state of alteration and vigorous promotion. Both deserve their acclaimed moniker of "the greatest story ever told."

### THE CROSS OF ATLANTIS

Transmitted along with the meme for Atlantis is its symbol or icon known as the *Cross of Atlantis*. As with the 'Living Cross', the Cross of Atlantis should be viewed as a living structure, both metaphorically and technologically.

The capital of Atlantis was a maritime city with an enormous port, having alternating zones of land and sea, divided into three zones. In the innermost ring was a sacred mountain, possibly a volcano, where the original race of Atlas arose. The Atlanteans built a royal palace atop this hill and it became a 'marvel to behold for its size and beauty'. In the middle of the citadel was a temple dedicated to Poseidon and Cleiton.

This description of two great circles of land around an island, and three great circles of water around the land reveals the symbol for Atlantis known as the *Cross of Atlantis*.



*The Cross of Atlantis*

A symbol is a sign. As the great symbolist Jordan Maxwell notes in the introduction to *Stellar Theology*, a symbol indicates direction or it informs one of ownership. A sign is a logo that says this item belongs to this group. This Cross of Atlantis sign says "this place belongs to the gods. Humans keep out."

## STARGATE OF ATLANTIS



*Schliemann's City of the Golden Gates with Atlantis logo (1906). Its main characteristic is the shape of the water canals and the land zones together with the bridges forming the "Cross of Atlantis". The Center represents the capitol of Atlantis. Although Plato does not mention this center's name other traditions do record the name of the capital of Atlantis. **Meru** is the name of this center. the 4<sup>th</sup> century B.C. Greek historian Theopompus tells us that one of the names of the people who inhabited Atlantis were the **Meropes**, the people of **Merou**.*

The Atlantis logo is composed of a *sun disk*  or Cross of Light  embedded

in concentric rings  . According to Laurence Gardner, writing in *The Magdalene Legacy*, a cross within a circle is called a *Rosi-Crucis* – the Dew Cup – and is the original symbol for the Holy Grail.



*The concentric rings.*

## STARGATE OF ATLANTIS

The concentric rings primarily symbolize vibration. In addition, they can represent a vortex. As in the example from NASA below, the concentric rings also may represent a two-dimensional expression of a three-dimensional experience: that of traveling through interstellar passageways called *stargates* or *wormholes*. This fact offers extraordinary possibilities when interpreting the Atlantis meme and is one that I'd like to go into here.

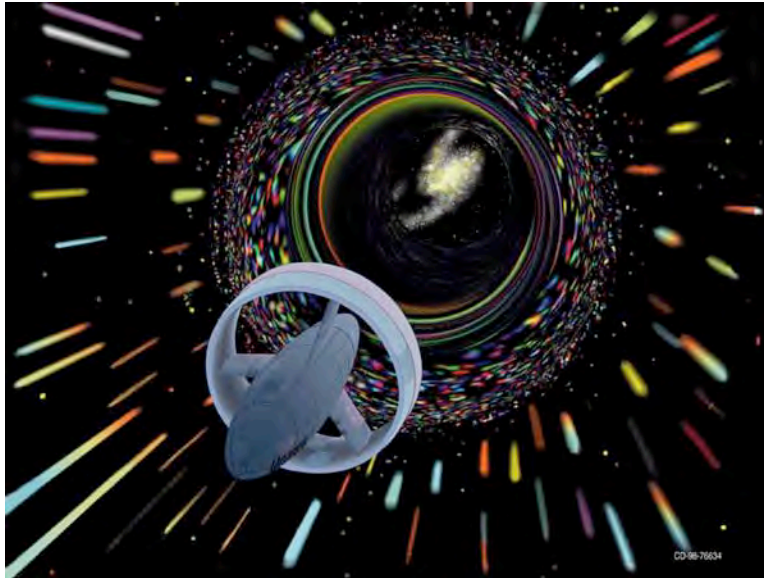

[www.nasa.gov/centers/glenn/multimedia/artgallery/art\\_feature\\_001\\_CD1998\\_76634.html](http://www.nasa.gov/centers/glenn/multimedia/artgallery/art_feature_001_CD1998_76634.html)

This hypothetical spacecraft with a “negative energy” induction ring was inspired by recent theories describing how space could be warped with negative energy to produce hyperfast transport to reach distant star systems. In the 1990s, NASA Glenn Research Center lead the Breakthrough Propulsion Physics Project. NASA’s primary effort to produce near-term, credible, and measurable progress toward the technology breakthroughs needed to revolutionize space travel and enable interstellar voyages.

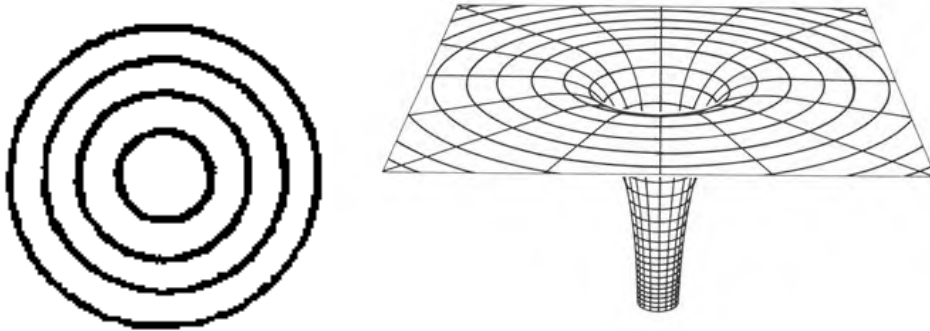

*The 2-D rings symbolize a 3-D vortex.*

## STARGATE OF ATLANTIS

In the past few years the scientifically rooted concept of wormholes and star gates, also called the Einstein-Rosen bridge, have become popular topics of such television shows as *Star Trek: The Next Generation* and *Sliders* and movies such as *Stargate* and *Contact* which feature ancient stargate technology for opening wormholes in space/time.

When the concentric rings of Atlantis are interpreted as a vibration -- a ring or a stargate -- it suggests that as a creation tale one of the most important concepts that the theory of Atlantis embodies is the *stargate*.

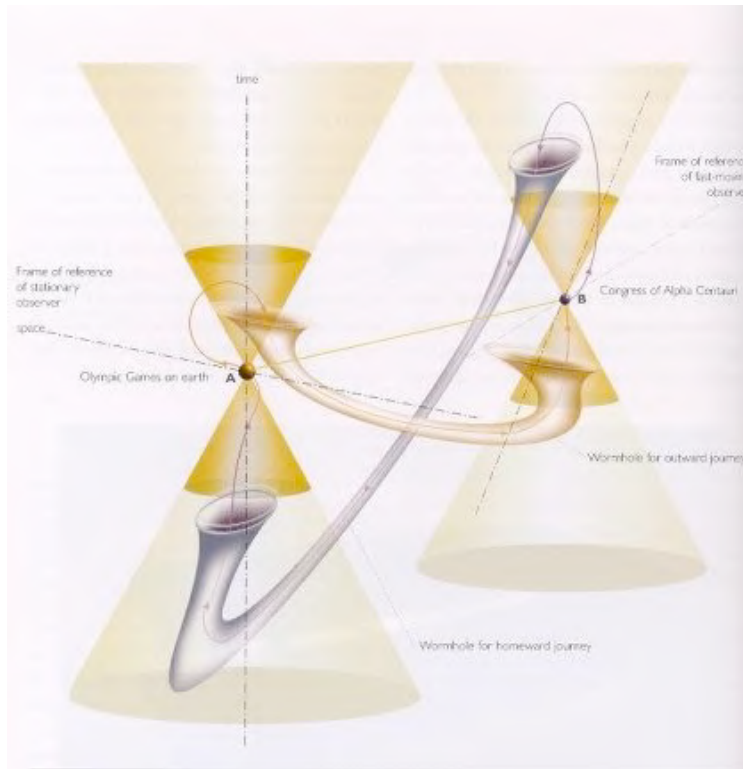

*A modern depiction of a wormhole.*

Theoretically, physicists view wormholes as time machines that may open gateways to parallel dimensions. They are the subjects of intense scientific research in America and Europe.

If we apply the three-dimensional approach to the two-dimensional concentric rings of Atlantis, we may hypothesize that it symbolizes a vortex. The Great Cross of Atlantis may be thought of as a *Great Crossing place*, a place of passage, to pass through one realm to another. Perhaps even to pass over the stars or pass through the galaxy.

As mentioned, the symbol of Atlantis is derived from the description of the enclosure constructed by the gods to protect the original sacred hill of Atlantis. As noted by Plato, the gods built this enclosure to keep humans out. Therefore, the sign of Atlantis could read "Atlantis: Property of the gods. Humans keep out."

In this capacity the Cross of Atlantis is identical to the Gate of Eden. Because Adam and Eve were disobedient to Yahweh, the god of Eden sent them out of the Garden of



## STARGATE OF ATLANTIS

Eden (Genesis 3:23). He placed at the east of Eden Cherubims, and a flaming sword which turned every way (it rotated gyroscopically), to keep the way of the way of the tree of life. Significantly, the Tree of Life is equated with the Cross. Therefore, the description of the mysterious Gate of Eden is of a rotating gate. The description of the rotating gate of Eden brings to mind a gyroscope and also the alien Stargate Machine featured in the Warner Brothers movie *Contact* (1996).



*A gyroscope.*



*The gyrosopic Stargate Machine from the movie Contact.*

STARGATE OF ATLANTIS



*Two Nubian figures stand beside a pillar in the middle of the Egyptian symbol for gate*



## STARGATE OF ATLANTIS

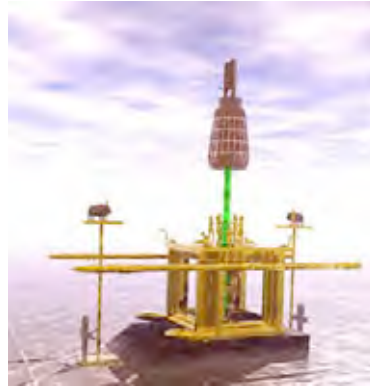

*The pillar at the center of the image is the one featured in the drawings on the left and right. It belonged to Osiris. It was called the Stairway to Heaven. For more on this pillar please see my article The Ark's Missing Piece in the articles section of [www.williamhenry.net](http://www.williamhenry.net).*



*The Sumerian sun god entered Earth through a gateway  with a tree that resembles Osiris' pillar beside it.*

I can hear the reader thinking are you bleeping kidding me? The average person, let alone a credentialed archaeologist, when discussing such a phenomenon as Atlantis can barely accept the idea of vanished civilization. Adding to this mix the possibility that the inhabitants were advanced, possibly even vastly advanced from our hyper-technological civilization is *nonsense, babbling* ('Babel' in Hebrew, a word which originally meant 'gate').

This is as unique as it is revolutionary. It is also quite hopeful as the concept of Atlantis rising is the jewel of many prophecy hunters. As we will see, wormhole symbolism is rampant in the story of Atlantis. It suggests that the rising of Atlantis has to do with the rise of theoretical physics.

## STARGATE OF ATLANTIS

For instance, in his discourse *Phaedo*, Plato records the astonishing revelation of Socrates in the last moments before his execution that “*the true Earth itself looks from above, if you could see it, like those twelve-patched leather balls*”.

A twelve-patched leather ball describes a dodecahedron. The dodecahedron with twelve five-sided faces was used as a teaching tool to instruct the initiate to know him or herself as an energy system like the Earth. Incredibly, a new study of only recently available scientific data hints that the universe is roughly shaped like a soccer ball, a dodecahedron.

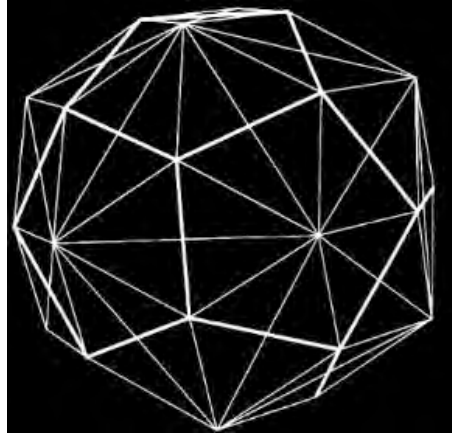

*Dodecahedron.*

Remarkably, Plato is describing Earth as a three-dimensional pentagonal web into which the soul incarnates. The ancient Greeks likely learned from the Egyptians that the human body is ideally structured geometrically to interface with the dodecahedron and its pentagonal grid.

Plato was not alone in his understanding of the 12-sided Earth. The Cherokee held a complimentary belief. In addition, the second century AD, a group of Christian Gnostics described the sphere of Earth being surrounded by a 12-angled pyramid. These 12 angles are described as “eyes”, “pipes,” and even more fascinating to our investigation, as “holes” or “halls” in the Earth! *These*, it appears, are the gates of the New Jerusalem.

Today, most researchers into sacred Earth energies concur that the Planetary Grid has 12 primary vortex zones, “halls” or “holes” with the Great Pyramid at the apex control. A network of temple sites throughout the Earth marks the Grid. These sites roughly include:

- the Great Pyramid of Giza and Heliopolis (“the City of the Sun”)
- the 1,000 foot high pyramids of southern China, 90 degrees opposite of Giza.
- Easter Island, 180 degrees opposite the Great Pyramid.
- the City of the Sun at prehistoric Cuzco, Peru.
- Teotihuacan in Mexico.
- the vortices of the Four Corners area of the USA.
- the Mississippi valley of the southeastern USA.
- Oak Island, Nova Scotia.
- the South of France, centered at Rennes-le-Chateau, France.

# STARGATE OF ATLANTIS

The 12-fold form is found in numerous mythic structures including these;

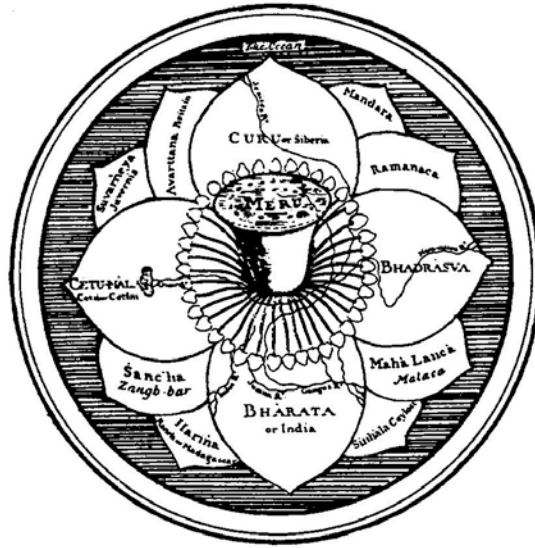

*Meru, the center of Atlantis, enfolded within a 12-petaled lotus.*

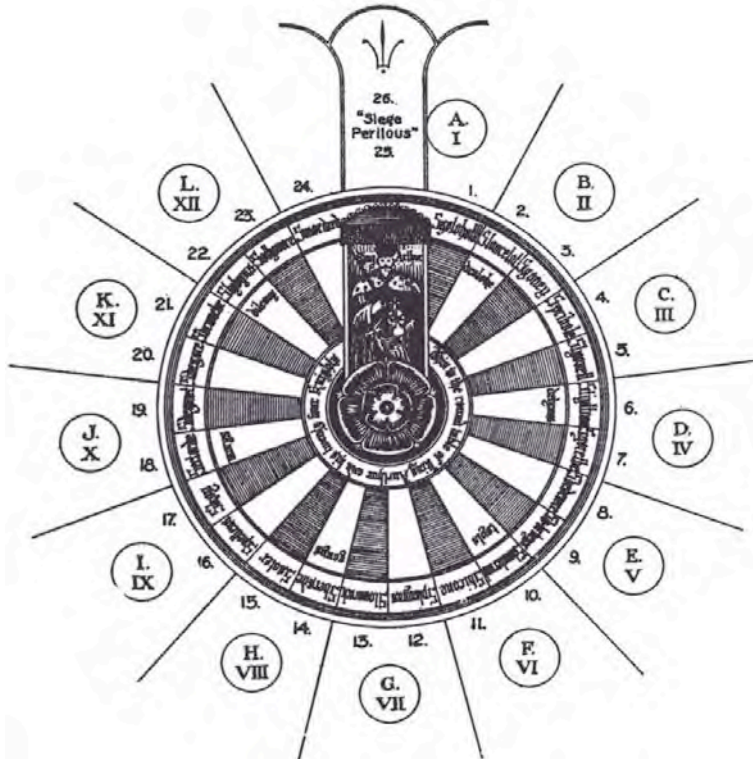

*Arthur's rather Atlantean Roundtable.*

STARGATE OF ATLANTIS



*The Mount of Salvation at the center of a zodiac.*

The activation of this 12-fold Planetary Grid is called the ‘quickenings’ of the Earth, an increase in the vibratory levels of humanity and Earth which is thought to spark higher intelligence and increased linkage between minds. The Quickening of our civilization is a result of the “quick-beams” or “quick-rays” emanating from the core of our galaxy and likely radiating through the Meru or Center of Atlantis.

**MERU: THE WORLD MOUNTAIN**

Meru is called the World Mountain. Turning to Buddhist imagery we find a remarkable image of Meru.

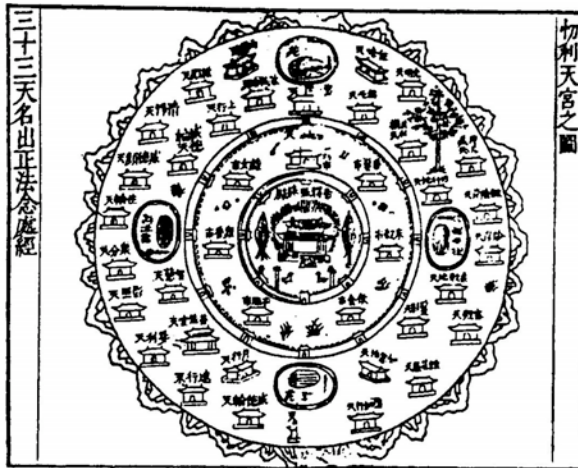

*The logo for Atlantis (left). Mandala of Meru, the center of Atlantis, from the top down perspective (Samuel Beal, London, 1882). Meru appears as a concentric ring. One*

*wonders if this is the ring at the top of the Meru symbol*  .

## STARGATE OF ATLANTIS



The hourglass (or wormhole-shaped)  $\nabla$  World Mountain, Meru, rises from the great ocean of space, (Japan, 1678). The wormhole shape suggests Meru was a gateway to another dimension.

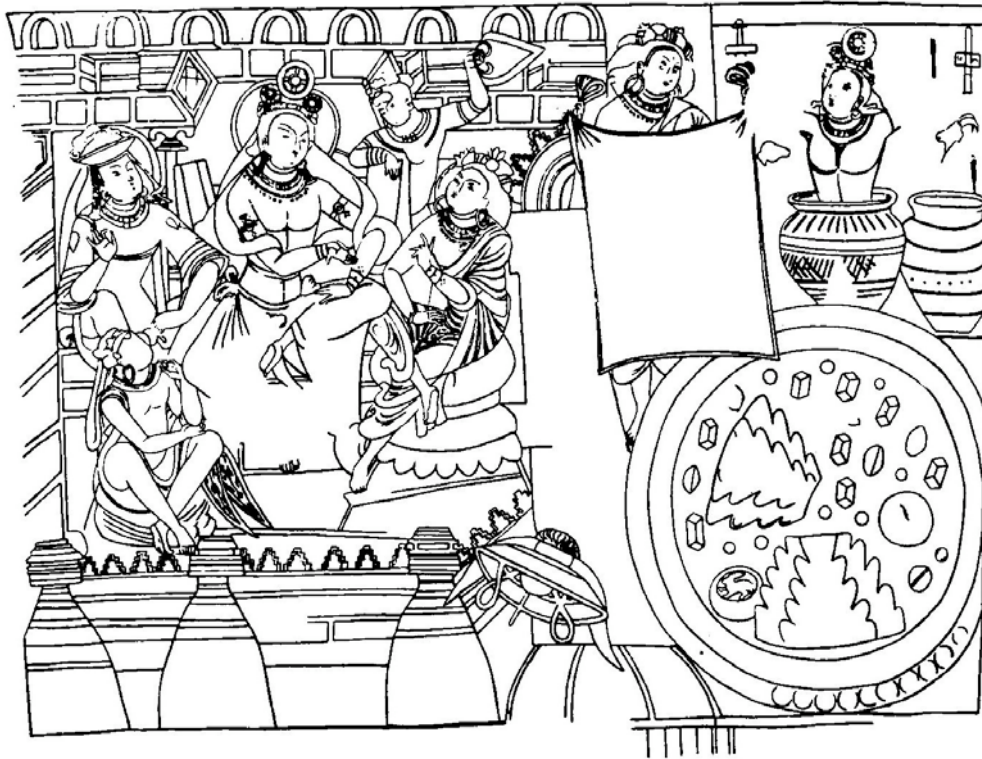

The Buddha's death caused the collapse of the world-pillar Meru. In the lower right it shatters into curious cubes that suggest crystals or even other dimensions.

## STARGATE OF ATLANTIS

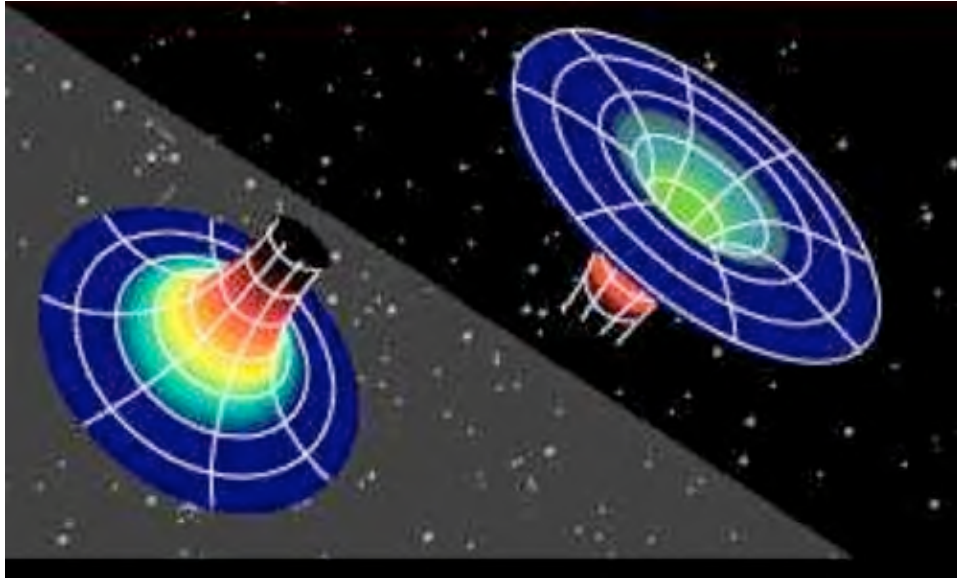

*The collapse of a wormhole.*

Given the puns we have explored, could the *world* mountain Meru actually be a

*whirled*, whirling or spinning  , mountain?



*Interestingly, the Meru is believed to have been the model for the Tower of Babel, located in Su-Meru or Sumer. Further, as spinning is the same as turning (from tour), does this indicate the Tower of Babel was a spinning or turning pillar?*



## STARGATE OF ATLANTIS

It is said that once Buddha achieved enlightenment he placed a victory banner on the summit of Mt. Meru, symbolizing his victory over the entire universe. Again, Mount Meru here is believed to be the central axis supporting the world.

The flag of victory also denotes Buddha's triumph over Mara, who personifies hindrances on the path to spiritual realization. Specifically, there are said to be four types of Maras, each one representing an individual hurdle on the path to spiritual progress. These are:

- 1). The Mara of Emotional Defilement
- 2). Mara of Passion
- 3). Mara of the Fear of Death
- 4). Mara of Pride and Lust

It was only after conquering these four negative traits that Buddha could proclaim victory over ignorance, and achieve nirvana.

Here, it is worth a brief diversion to note that in calling Jesus 'the Way' the early Christians were following in the footsteps of the Buddhists. Just as converts to Christianity living long after the fact altered the images of Jesus, a similar artistic make-over was applied to Buddha. Early Buddhist art consisted of symbolic representations of Buddha. It was customary to represent the Buddha as a pair of footprints indicating the way to walk to enlightenment, or as an 8-spoked wheel, the symbol for the *Wheel of Truth*, the Anunnaki symbol of king ship.



*The Dharma Wheel symbol of the 8-fold Path of Buddha or the Universal Law.*

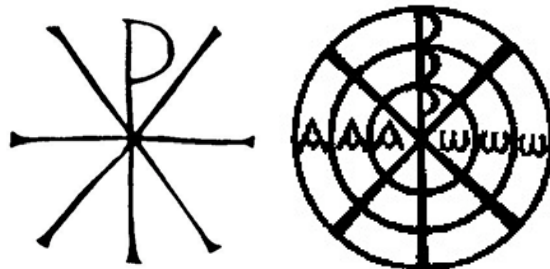

*Early Christian 8 rayed wheels.*

## STARGATE OF ATLANTIS

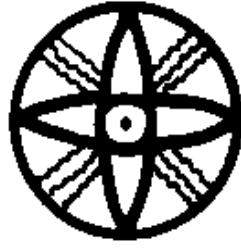

*The 8-rayed symbol of the Nibiru (gate).*

Wherever archaeologists discovered remains of the early Sumerian civilizations the symbol of the “the Gate of the Gods” was prominently displayed. The Sumerian god Enki became Poseidon in the story of Atlantis.

The Sumerians depicted this gate as an eight-pointed star ✱. This star-sign denoted such terms as *an*, the ‘Lord Anu’; *dingir*, the ‘Bright One’; *an*, ‘high’; and *ana*, or *an*, ‘heaven’. It was often found as a determinant in front of the names of the Shining Ones. Thus, *dingir E.A.* indicated the ‘Shining Lord of Waters’.

Sitchin assigns the Babylonian version of the symbol of the Cross of Light to Enki’s home world the *Nibiru*, which means ‘crossing place’ or ‘gate’.

## THE PARTICLE ACCELERATOR OF ATLANTIS

Relaxing after a presentation on this subject in Florida a few years ago, a scientist approached me. He told me he was asleep through most of my presentation... until I “put up that blueprint.”

“Blueprint? What blueprint?” I asked.

He fished through my slides until he came to a 2<sup>nd</sup> century drawing of the Meru pillar or tower (next page). In my talk I had presented it as an example of a possible ‘Grail tuner’ and a candidate for the rod shown in Jesus’ hand in early Christian art. (For more please see my article *Jesus, FDR and the Meru Superantenna.*)

That blueprint,” he responded.

Studying the drawing, the scientist told me that he designed particle beam weapons for a living. Laser cannons. Light sabers. “You know, Stars Wars-type weapons,” he said.

“Your Meru drawing is a blueprint for a particle accelerator and a particle beam weapon,” he said knowingly. Squeezing his thumb and forefinger together to mimic a pincer, he said the weapon is designed to rotate on the circular platform. The ‘horns’ modulate the pulse emanating from the weapon.

## STARGATE OF ATLANTIS



*Late in 2004 digital artist Jack Andrews rendered the Meru drawing in 3-D on a computer.*

## STARGATE OF ATLANTIS

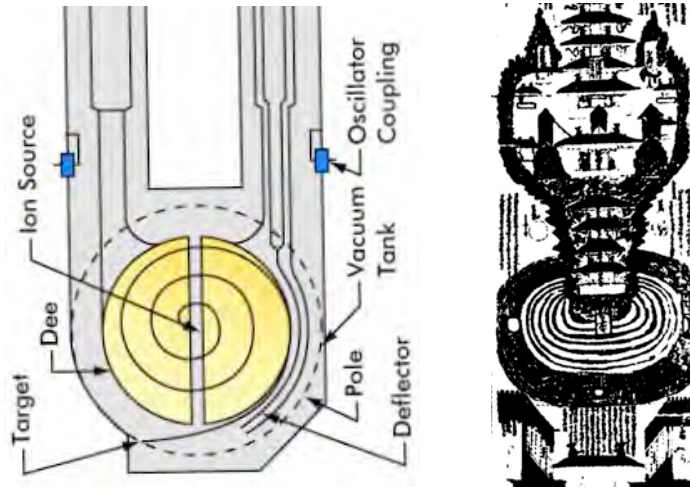

*A cyclotron consisted of two large dipole magnets designed to produce a semi-circular region of uniform magnetic field, pointing uniformly downward.*

Presented here is a comparison of the base of the Meru drawing with a plan for a cyclotron, a particle accelerator designed by Ernest O. Livermore in 1929 and developed in the early 1930s (coincident with America's shift to a technologically based society). The cyclotron was a necessary technology used in the splitting of the atom and the development of the A-bomb.

Glancing at the drawings it is easy to see why the scientist saw a similarity between the two designs. The question is: What in the world is a blueprint for a particle accelerator doing in a 2<sup>nd</sup> century Chinese manuscript?!

One can see that the Meru drawing is an axis that resembles an antenna (or a microwave weapon from *Star Wars*). There's a reason for this. One well-known scholar of Buddhism quoted by Victoria LePage, Lama Anagarika Govinda, says Meru is "the seat of cosmic powers, the axis which connects the earth with the universe, *the super-antenna for the inflow and out flow of the spiritual energies of our planet.*" Today, scientists call these 'spiritual energies' *high energy cosmic rays*.

This astonishing drawing was among the famed Tunhuang Manuscripts discovered in the secret repository the Cave of the Thousand Buddhas early in the 20<sup>th</sup> century by Hungarian-born explorer Marc Aurel Stein. According to the Order of Nazorean Essenes website (Essenes.net), numerous 3<sup>rd</sup> century Manichaeon-Christian manuscripts were part of the Tunhuang 'hall of records'.

Historians claim monks in hidden monasteries in Central Asia trained Issa ("Jesus") during his 18 'missing' silent years between 12 and 30. He traveled the mountain passes and taught widely in the monasteries and markets.

On the next page, we see a comparison of apex of the Meru pillar with the cone featured in a scene etched onto a golden plate and presented to King Tutankhamun. Author Z. Sitchin proposes this an Anunnaki space craft on a silo.

## STARGATE OF ATLANTIS

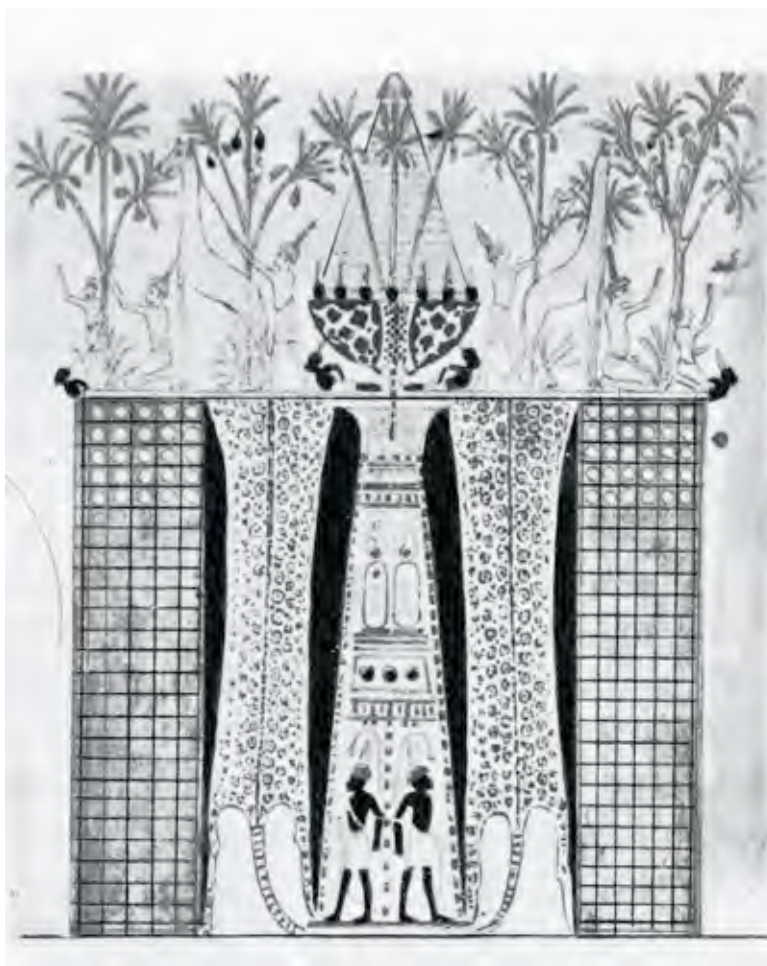

*Bottom Right. Top right: A drawing etched onto a gold plate presented to King Tutankhamen made by Nubian goldsmiths. Z. Sitchin proposes it is an Anunnaki craft on a silo. The stargate model proposes it is a warp craft instead. Note the pillar at the bottom center of the drawing.*

## STARGATE OF ATLANTIS



*Detail of the base of the Meru pillar rendered in 3-D by Jack Andrews. It creates a ring or a vortex. Note , the arrangement of the Central (or Whirling) Mountain surrounded by four subsidiary peaks.*



*The Cross of Atlantis with the Meru pillar in the center by Dana Augustine (left). The apex of the Meru pillar, the 'warp craft', by Jack Andrews (right).*

## STARGATE OF ATLANTIS

My working hypothesis is that this diagram, schematic or blueprint is a *mandala* whose symbols point to the function of the actual thing... an instrument of some kind capable of conducting the spiritual energies of the planet.

Mandalas are “read” or memorized for visualization during meditation. They are blueprints of the three-dimensional palace of the deity. The purpose of the mandala is two-fold: to acquaint the student with the symbols of the deity (i.e. Buddha, Christ) and to allow the student to “enter into the mandala”; that is, to enter the frequency or vibration in which the deity lives, i.e. ‘Meru’.

This is how the mystics of Shambhala were raised from a man to a god-man. They mastered the Meru symbolism. This raised the vibration of their mind and body and he entered the mysterious realm of Shambhala.

In the diagram of the base of the Meru pillar we notice it has four sides. The arrangement of the Central (or Whirling) Mountain surrounded by four subsidiary peaks is found in the Navajo sandpainted mandalas also corresponds to that of Mt. Meru, flanked by its Four Guardians and their corresponding four subsidiary mountain peaks. In India, as with the Navajos, the Four Guardians are also represented as either gods (Lokapalas), mountains, snakes (Nagas) or birds (Garudas), which are frequent animal shapes assumed by them.

Moreover, each of the Four Hindu Guardians is also associated with a heraldic color, in exact correspondence to the Navajo ones: White, Yellow, Black and Red. These, of course, are the four races of humanity, which originated in Eden or Atlantis, according to legend.

The Four Guardians are sometimes represented by the Four Trees or by Winds, Suns, Moons, Archangels, Bats (Vampires), Thunderbolts, as well as by Coiled or by Standing Serpents resembling zigzag lightning and ball lightning.

STARGATE OF ATLANTIS

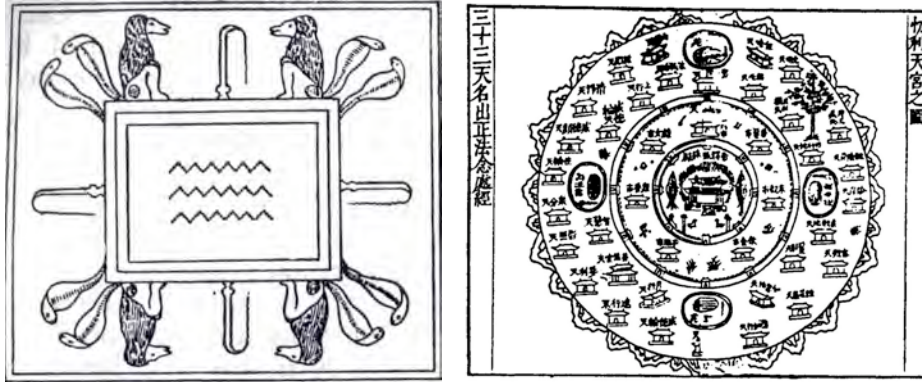

The four guardians. Egypt (left). Meru (right).

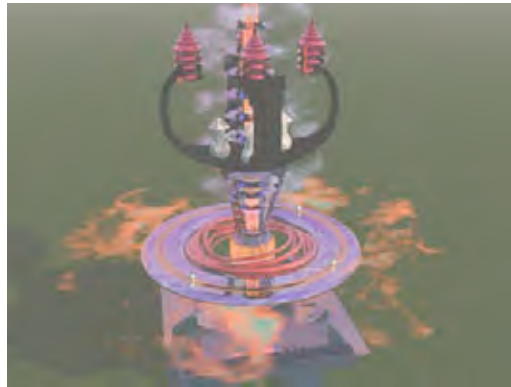

Each of these four drawings match what we would see viewing the four 'mountains' and the Meru particle accelerator from the top down.

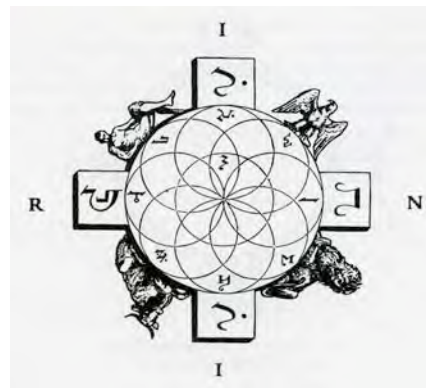
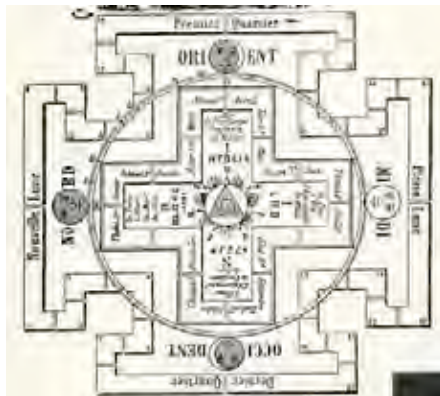

Solomon's Temple (left). The INRI cross of Christ (right).



## STARGATE OF ATLANTIS

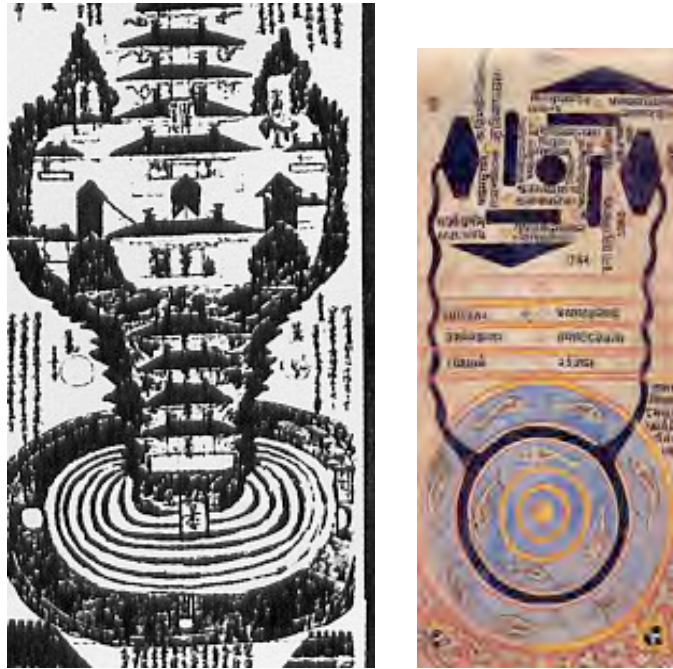

*The Meru pillar (left). Rose-Apple Land (Right).*

According to a conversation I had with a Tibetan White Sand Mandala designer, the concentric rings at the base of the Meru pillar represent *water*. This is confirmed by Philip Rawson in his book *The Art of Tantra* in which he presents a painting (above right) of *Rose-apple land*. I am most intrigued by this place name ‘Rose-apple land’. When we apply this place name to the perceived function of the Meru antenna or accelerator, it suggests that it created a force field.

A particle accelerator is an electrical device that generates charged particles, such as electrons, protons and ions, at high energy. So-called “nuclear accelerators” are used to split the atom for scientific research, but most particle accelerators are built for more practical applications. They are used to manufacture a myriad of products including semiconductors. They are also used as X-ray machines for cancer treatment and for detecting weaknesses in materials.

## STARGATE OF ATLANTIS



*One of the early particle accelerators responsible for development of the atomic bomb. Built in 1937 by Philips of Eindhoven it currently resides in the National Science Museum in London, England.*



*Particle accelerator.*

## STARGATE OF ATLANTIS

The Large Hadron Collider (LHC) is being built at CERN, the European laboratory for nuclear research. Costing \$3 billion and expected to be completed in 2007, it will be the largest particle accelerator in the world for nuclear research. While making 17-mile rings at nearly the speed of light, protons will be made to collide into other particles 10 million times per second. The main purpose is to find the Higgs boson, considered by some scientists to be the fundamental element of matter and often called the “God Particle.”

In addition, physicists hope to use the collider to answer the following questions:

- What is mass? (We know how to measure it - but what is it?)
- What’s the origin of mass of particles? (In particular, does the Higgs Boson exist?)
- Why do elementary particles have different masses? (I.e., do particles interact with a Higgs field?)
- We know that 95% of the universe’s mass is not made of matter as we know it. What is it? (I.e. what is dark matter, dark energy?)
- Do supersymmetric (SUSY) particles exist?
- *Are there extra dimensions, as predicted by various models inspired by string theory, and can we “see” them?*
- Are there additional violations of the symmetry between matter and antimatter?

As of June, 2005 no experiment has definitively detected the existence of the Higgs bosons. The search for the hypothetical elementary ‘God Particle’ is reminiscent of ancient metaphysics. According to the *Zohar*, manna, the food of the gods, is made (detected/produced) by a Manna machine strikingly reminiscent of the Meru pillar/particle accelerator. It starts its journey as *dew* and falls to the ‘field of *holy apples*’. The people who preserved these secrets called themselves the *Reapers of the Holy Field*. The fact that *manna* was called ‘blessing’ or ‘mercy’ (meru-cy) tell us the ‘holy field’ is a beneficial vibration. The reapers are the ones who know how to harvest the (blue) apples from this field. They use particle accelerators. (Later, we will compare the human body with these devises.)

It is CERN’s search for extra dimensions that is most intriguing to us. What will they find?

In addition, in the next few decades, the possibility of black hole production at the highest energy accelerators may arise, if certain predictions of superstring theory are accurate (Scientific American, May 2005). A black hole is an area of space-time with a gravitational field so intense that its escape velocity is equal to or exceeds the speed of light.

## STARGATE OF ATLANTIS

As we can see from the comparison of the spinning black hole presented here there is a striking similarity with the symbol of Atlantis.

I'll leave you to contemplate the similarity.

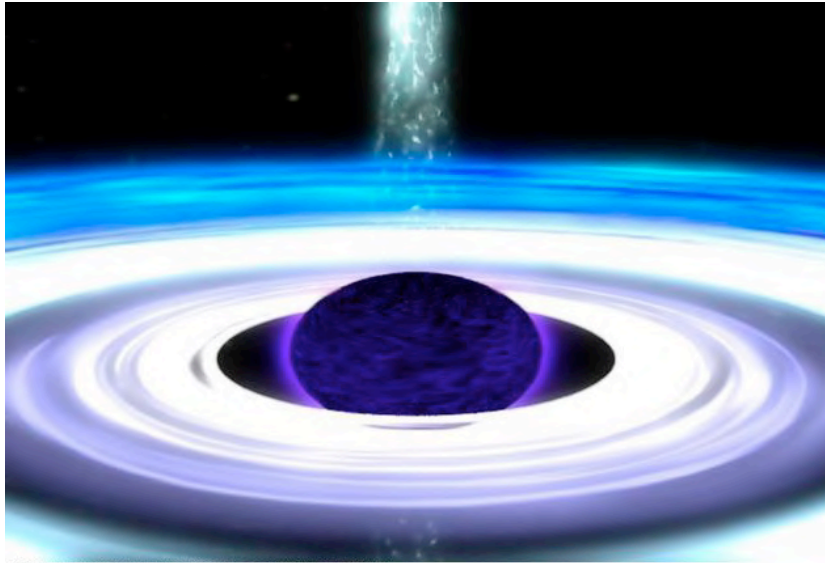

NASA/HONEYWELL MAX-Q DIGITAL GROUP/DANA BERRY

*This computer rendering shows matter whirling into a spinning black hole, whose shape is distorted and not spherical.*



*Atlantis.*